

# Product Specification

Document number: NMD-SPC- SK6808D-EC3227  
Product model: SK6808D-EC3227  
Product description: 3.2x2.7x1.08mm Type 0.12Watt Power Embedded  
Version number: 01  
Time: 2021-05-31



## CONTENTS

1、 Product overview.....	4
2、 Main Application Field.....	4
3、 Description.....	4
4、 Mechanical Dimensions.....	5
5、 PIN configuration.....	5
6、 Recommended dimensions for PCB products.....	5
7、 General description of product naming.....	6
8、 Electrical parameters.....	6
9、 Electrical/Optical Characteristics.....	6
10、 IC The electrical parameters.....	7
11、 Switching characteristics.....	7
12、 The data transmission time .....	8
13、 Timing waveform.....	8
14、 The method of data transmission.....	9
15、 The data structure of 24bit.....	10
16、 The typical application circuit.....	10
17、 Standard LED Performance Graph.....	11
18、 Packaging Standard.....	12
19、 Reliability Test.....	13

## 1. Product Overview :

SK6808D-EC3227 is a smart LED control circuit and light emitting circuit in one controlled LED source, which has the shape of a 3227 LED chip. Each lighting element is a pixel, and the intensities of the pixels are contained within the intelligent digital interface input. The output is driven by patented PWM technology, which effectively guarantees high consistency of the color of the pixels. The control circuit consists of a signal shaping amplification circuit, a built-in constant current circuit, and a high precision RC oscillator.

The data protocol being used is unipolar RZ communication mode. The 24-bit data is transmitted from the controller to DIN of the first element, and if it is accepted it is extracted pixel to pixel. After an internal data latch, the remaining data is passed through the internal amplification circuit and sent out on the DO port to the remaining pixels. The pixel is reset after the end of DIN. Using automatic shaping forwarding technology makes the number of cascaded pixels without signal transmission only limited by signal transmission speed.

The LED has a low driving voltage (which allows for environmental protection and energy saving), high brightness, scattering angle, good consistency, low power, and long life. The control circuit is integrated in the LED above.

## 2. Main Application Field:

- Full color LED string light, LED full color module, LED super hard and soft lights, LED guardrail tube, LED appearance / scene lighting
- LED point light, LED pixel screen, LED shaped screen, a variety of electronic products, electrical equipment etc..

## 3. Description:

- CHIP SMD internal integrated high quality external control line serial cascade constant current IC;
- control circuit and the RGB chip in EC3227 components, to form a complete control of pixel, color mixing uniformity and consistency;
- built-in data shaping circuit, a pixel signal is received after wave shaping and output waveform distortion will not guarantee a line;
- The built-in power on reset and reset circuit, the power does not work;
- gray level adjusting circuit (256 level gray scale adjustable);
- red drive special treatment, color balance;
- line data transmission;
- plastic forward strengthening technology, the transmission distance between two points over 10M;
- Using a typical data transmission frequency of 800 Kbps, when the refresh rate of 30 frames per sec

## 4. Mechanical Dimensions:

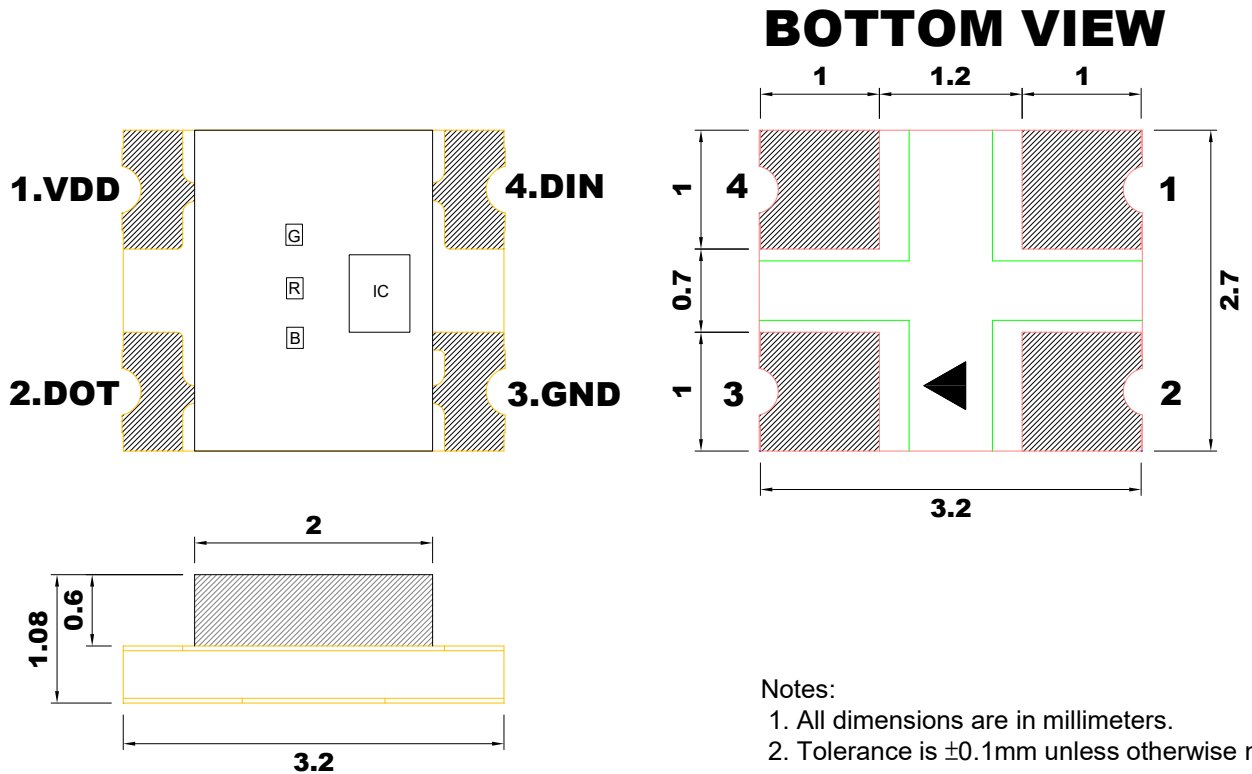

## 5. PIN configuration

NO.	Symbol	Function description
1	VDD	Power supply LED
2	DOUT	Control data signal output
3	GND	Ground
4	DIN	Control data signal input

## 6. Recommended dimensions for PCB

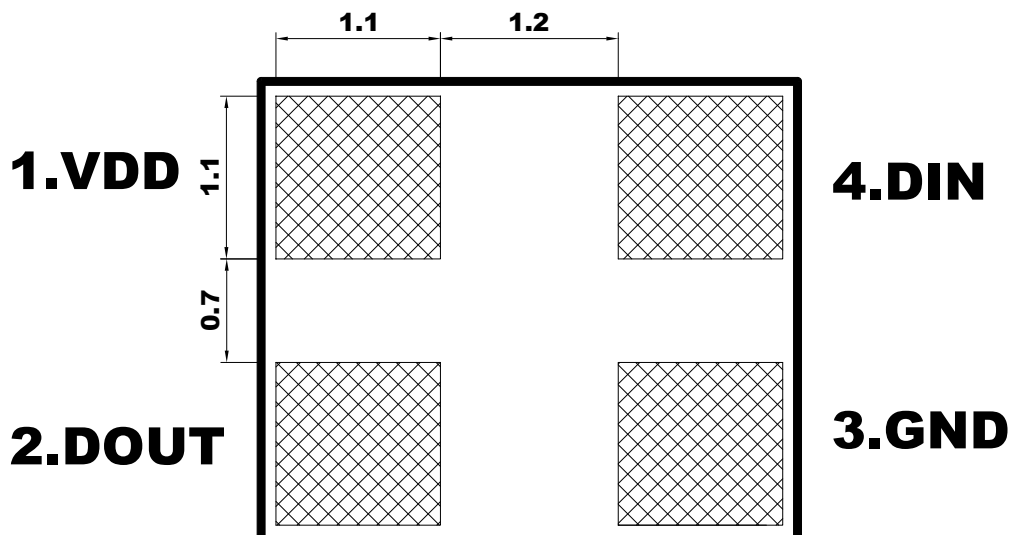

## 7. General description of product naming

# SK 6808 D-EC3227

①

②

③

④

①	②	③	④
Series	IC series and current code	epoxy resin color	Package outline
The default is to integrate the RGB chip with the IC	Refers to the 68 series IC 8mA current version	D indicates that the epoxy resin color is foggy and opaque	3.2x2.7x1.08mm PCB package outline

## 8. Electrical parameters (Ta=25°C,VSS=0V) :

Parameter	Symbol	Range	Unit
Power supply voltage	VDD	+3.7~+5.5	V
Logic input voltage	$V_{IN}$	-0.5~VDD+0.5	V
Working temperature	Topt	-40~+80	°C
Storage temperature	Tstg	-50~+80	°C
ESD pressure(HBM)	$V_{ESD}$	2K	V
ESD pressure(DM)	$V_{ESD}$	200	V

## 9. Electrical/Optical Characteristics:

SK6808D-EC3227 8mA		
Color	Dominate Wavelength(nm)	Luminance(mcd)
Red	620-630	80-320
Green	520-535	160-580
Blue	460-475	40-160

**10. IC The electrical parameters (unless otherwise specified, TA=-20 ~ +70 °C, VDD=4.5 ~ 5.5V, VSS=0V):**

Parameter	Symbol	Min	Typical	Max	Unit	Test conditions
The chip supply voltage	VDD	---	5.2	---	V	---
The signal input flip threshold	VIH	0.7*VDD	---	---	V	VDD=5.0V
	VIL	---	---	0.3*VDD	V	
The frequency of PWM	FPWM	---	1.0	---	KHZ	---
Static power consumption	IDD	---	0.65	---	mA	---

**11. Switching characteristics (VCC=5V Ta=25 °C):**

Parameter	Symbol	Min	Typical	Max	Unit	Test conditions
The speed of data transmission	fDIN	---	800	---	KHZ	The duty ratio of 67% (data 1)
DOUT transmission delay (Note 4)	T <sub>PLH</sub>	---	67	---	ns	The load capacitance of dout port to ground is 30pf, Signal transmission delay from DIN to dout
	T <sub>PHL</sub>	---	82	---	ns	
DOUT Conversion time (Note 5)	T <sub>TLH</sub>	---	9.6	---	ns	The load capacitance of dout port to ground is 30pf
	T <sub>THL</sub>	---	11.6	---	ns	
OUT R/G Conversion time (Note 6)	Tr	---	22	---	ns	I <sub>OUT</sub> = 8mA, out R / B port series connection 200 Ω electricResistance to VDD, load capacitance to ground 30pF
	Tf	---	75	---	ns	
OUT G Conversion time (Note 6)	Tr	---	18	---	ns	I <sub>OUT</sub> = 8mA, out G port series connection 200 Ω electricResistance to VDD, load capacitance to ground 30pF
	Tf	---	110	---	ns	

Note 4、Note 5、Note 6 : As shown in the figure below

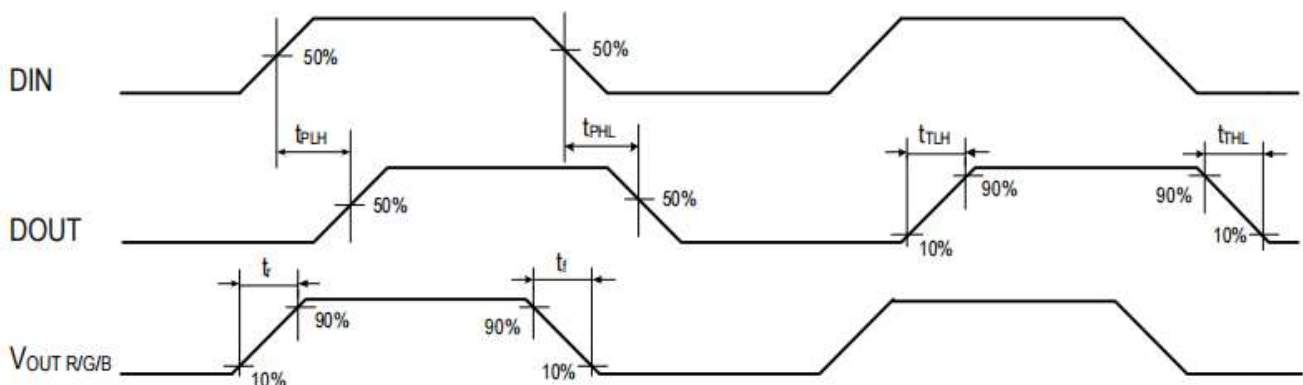

## 12. The data transmission time :

Name		Typical value	Tolerance range	Unit
T	Code period	1.2	--	μs
T0H	0 code, high level time	0.3	±0.05	μs
T0L	0 code, low level time	0.9	±0.05	μs
T1H	1 code, high level time	0.9	±0.05	μs
T1L	1 code, low level time	0.3	±0.05	μs
Trst	Reset code, low level time	> 200	--	μs

1. The protocol uses a unipolar zeroing code. Each symbol must have a low level. Each symbol in this protocol starts with a high level. The high time width determines the "0" or "1" code. .
2. When writing programs, the minimum symbol period is 1.2μs.
3. The high time of "0" code and "1" code should be in accordance with the stipulated range in the above table. The low time requirement of "0" code and "1" code is less than 20μs.

## 13. Timing waveform:

Input code:

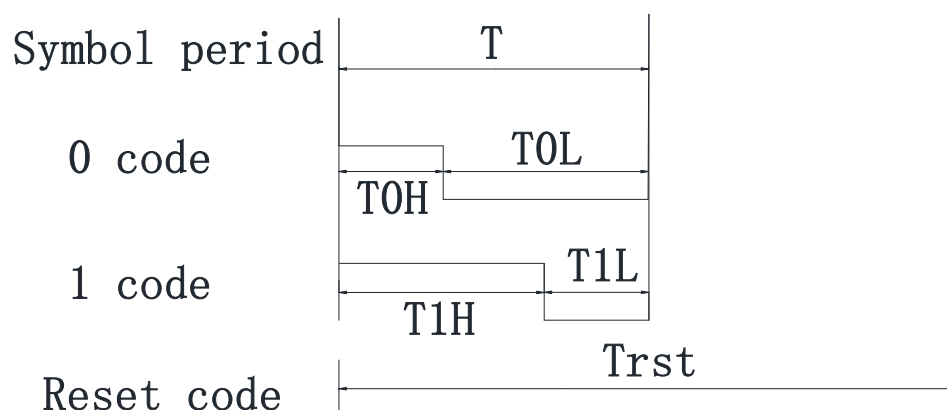

Connection mode:

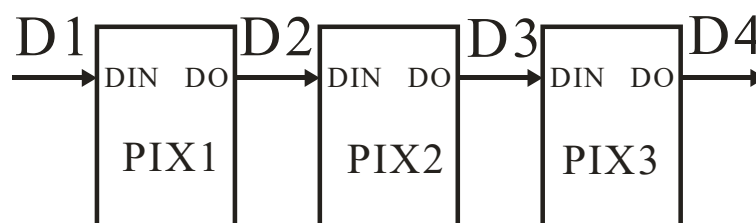

## 14. The method of data transmission:

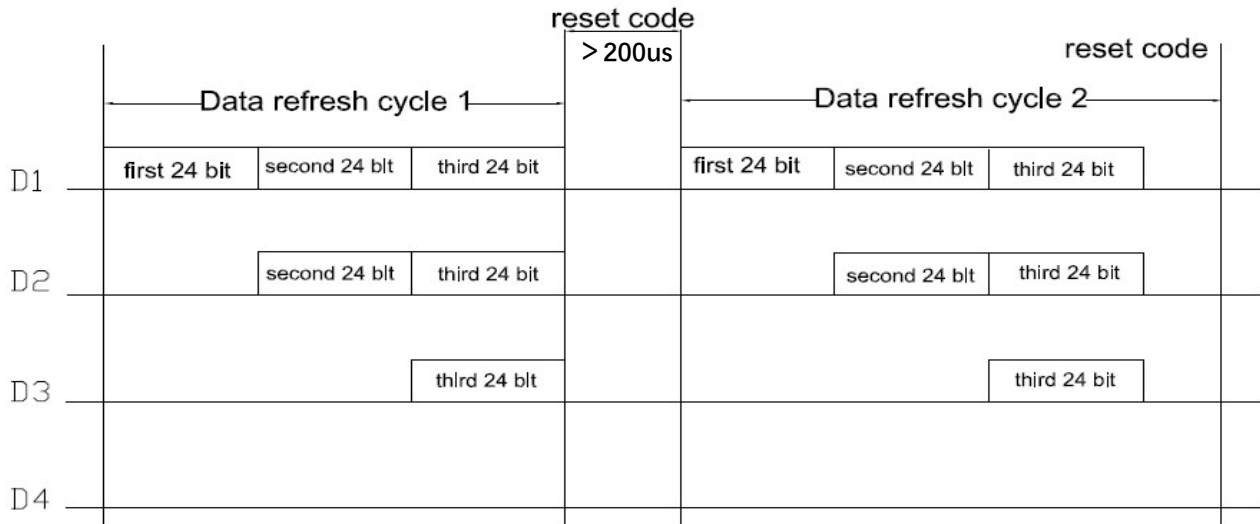

Note: the D1 sends data for MCU, D2, D3, D4 for data forwarding automatic shaping cascade circuit.

## 15. The data structure of 24bit:



Note: high starting, in order to send data (G7 - G6 - ..... ..B0)

## 16. The typical application circuit:

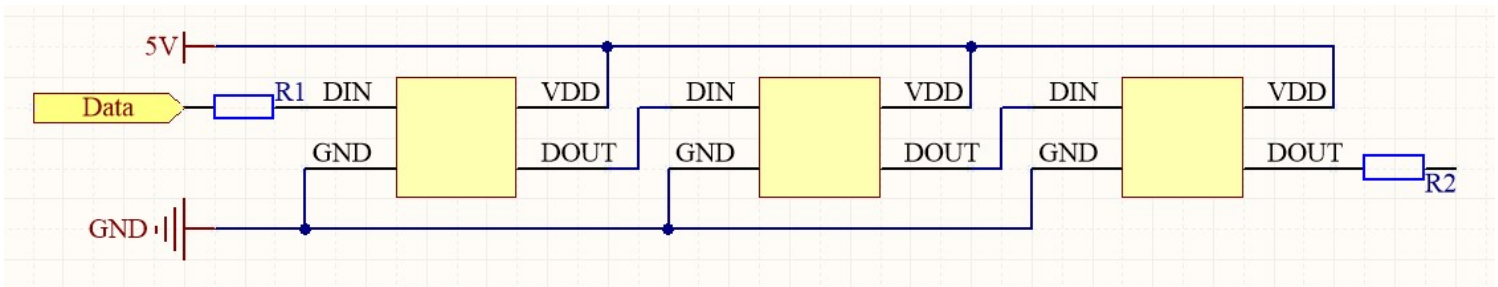

In the practical application circuit, the signal input and output pins of the IC signal input and output pins should be connected to the signal input and output terminals. In addition, in order to make the IC chip is more stable, even the capacitance between beads is essential back;

Application: used for soft lamp strip or hard light, lamp beads transmission distance is short, suggested in signal in time the clock line input and output end of each connected in series protection resistors, R1 of about 500 ohms.

Application: for module or general special-shaped products, lamp beads transmission distance is long, because of different wire and transmission distance, in the signal in time clock at both ends of the line on grounding protection resistance will be slightly different; to the actual use of fixed;



## 17. Standard LED Performance Graph:

Thermal Pad Temperature vs. Relative Light Output

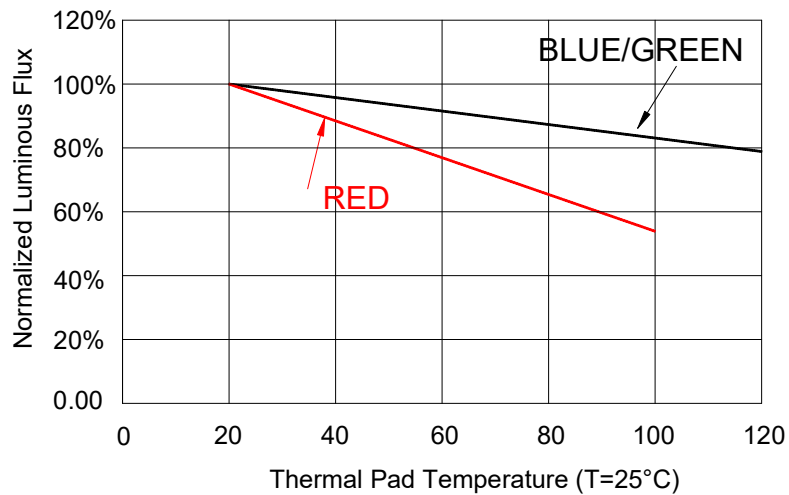

Wavelength Characteristics

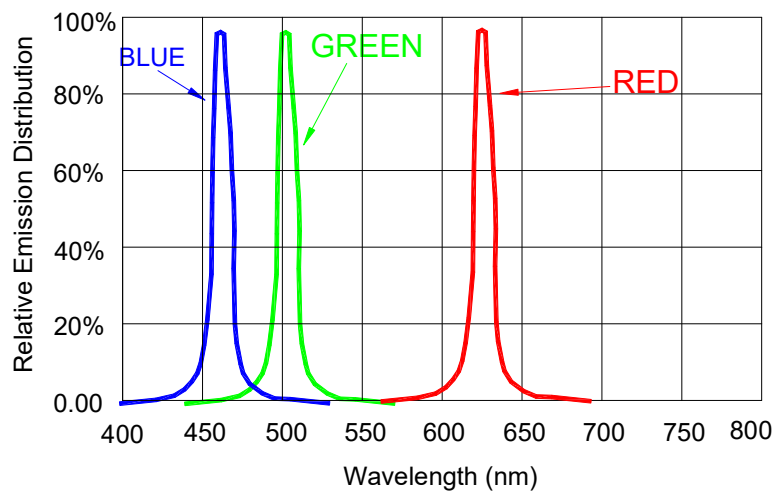

Typical Radiation Pattern 160°

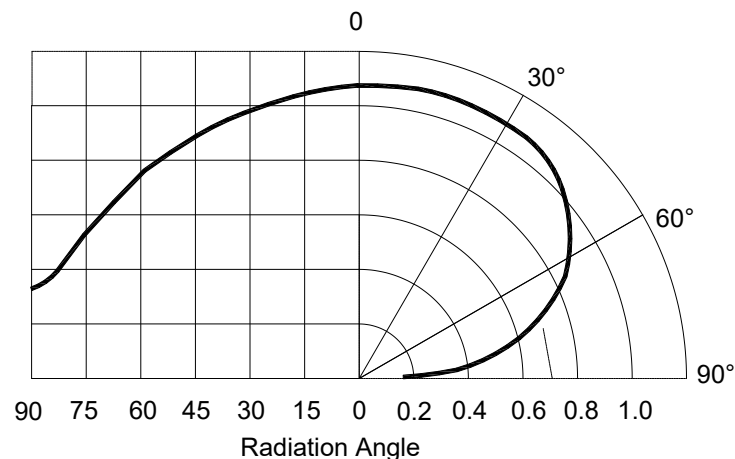

## 18. Packaging Standard:

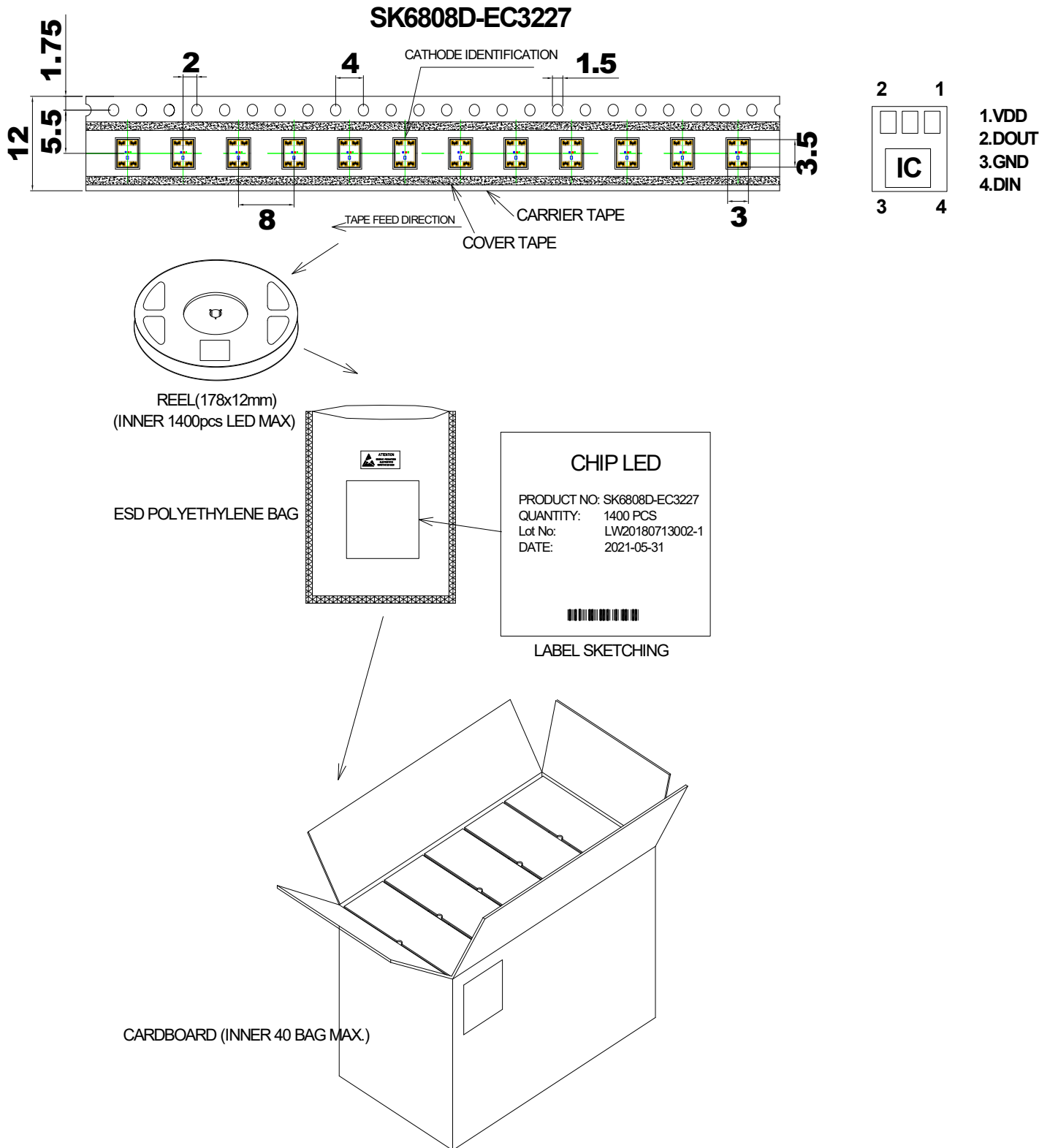

The reel pack is applied in SMD LED. The LEDs are packed in cardboard boxes after packaging in normal or anti-electrostatic bags. cardboard boxes will be used to protect the LEDs from mechanical shocks during transportation. The boxes are not water resistant and therefore must be kept away from water and moisture.

# Shenzhen Normand Electronic Co.,Ltd

---

## 19. Reliability Test :

NO.	Test item	Test Conditions	Reference	Criterion
1	Thermal Shock	$-20 \pm 5^{\circ} \text{C} \sim 80^{\circ} \text{C} \pm 5^{\circ} \text{C}$ 15min~15min 100 cycles	MIL-STD-202G	0/22
2	High Temperature Storage	Ta= +100°C 1000hrs	JEITA ED-4701 200 201	0/22
3	Low Temperature Storage	Ta= -40°C 1000hrs	JEITA ED-4701 200 202	0/22
4	High Temperature High Humidity Storage	Ta=60°C RH=90% 1000hrs	JEITA ED-4701 100 103	0/22
5	Temperature Cycle	$-20^{\circ}\text{C} \sim 25^{\circ}\text{C} \sim 80^{\circ}\text{C} \sim 25^{\circ}\text{C}$ 30min~5min~30min~5min 100 cycles	JEITA ED-4701 100 105	0/22
6	Resistance to Soldering Heat	Tsld = 260° C, 10sec. 2 times	JEITA ED-4701 300 301	0/22
7	Room temp Life Test	25° C, IF: Typical current , 3000hrs	JESD22-A 108D	0/22

## Criteria for Judging the Damage:

Item	Symbol	Test Condition	Limit	
			Min	Max
Luminous Intensity	IV	DC=5V, Typical current	Init. Value*0.7	---
Resistance to Soldering Heat	---	DC=5V, Typical current	No dead lights or obvious damage	