

SK6812SIDE-FRGBW-BW-P6

4.8x1.8x1.6 mm 0.25W Intelligent External Control
Surface Mount SMD Side Light Emitting LED



Change History

Date	Rev. No.	Changes/Reason of changes	Signature
2020-06-08	Interim version	Initial Document	KEVIN ZHU

* Before using our products, please search our official website to check the version of specifications. The version of product specifications is updated. We are sorry to fail to inform you in time. Please refer to the latest information on the official website.

* The copyright and final interpretation of the product belong to Shenzhen Normand Electronic Co.,Ltd. If you have special specifications, please contact our engineering staff;

*Official website: <https://www.normandle.com>

Shenzhen Normand Electronic Co.,LTD

CONTENTS

1、Product overview.....	3
2、Main Application Field.....	3
3、Description.....	3
4、Mechanical Dimensions.....	3
5、PIN configuration.....	4
6、Recommended dimensions for PCB products.....	4
7、General description of product naming.....	4
8、Electrical parameters.....	5
9、Electrical/Optical Characteristics.....	5
10、The IC electrical parameters.....	5
11、Switching characteristics.....	6
12、The data transmission time	6
13、Timing waveform.....	7
14、The method of data transmission.....	7
15、The data structure of 32bit.....	8
16、The typical application circuit.....	8
17、Wavelength classification specification.....	9
18、White Color Temperature Ranks.....	10
19、Standard LED Performance Graph.....	11
20、Packaging Standard.....	12
21、Reliability Test.....	13
Appendix 1、TOP SMD LED Application Notes.....	14~18

Shenzhen Normand Electronic Co.,LTD

1. Product Overview :

SK6812SIDE-FRGBW-BW-P6 is a smart LED control circuit and light emitting circuit in one controlled LED source, which has the shape of a 4818 LED chip. Each lighting element is a pixel, and the intensities of the pixels are contained within the intelligent digital interface input. The output is driven by patented PWM technology, which effectively guarantees high consistency of the color of the pixels. The control circuit consists of a signal shaping amplification circuit, a built-in constant current circuit, and a high precision RC oscillator.

The data protocol being used is unipolar RZ communication mode. The 32-bit data is transmitted from the controller to DIN of the first element, and if it is accepted it is extracted pixel to pixel. After an internal data latch, the remaining data is passed through the internal amplification circuit and sent out on the DO port to the remaining pixels. The pixel is reset after the end of DIN. Using automatic shaping forwarding technology makes the number of cascaded pixels without signal transmission only limited by signal transmission speed.

The LED has a low driving voltage (which allows for environmental protection and energy saving), high brightness, scattering angle, good consistency, low power, and long life. The control circuit is integrated in the LED above.

2. Main Application Field:

- Full color LED string light, LED full color module, LED super hard and soft lights, LED guardrail tube, LED appearance / scene lighting
- LED point light, LED pixel screen, LED shaped screen, a variety of electronic products, electrical equipment etc..

3. Description:

- Top SMD internal integrated high quality external control line serial cascade constant current IC;
- control circuit and the chip in SMD 4818 components, to form a complete control of pixel, color mixing uniformity and consistency;
- built-in data shaping circuit, a pixel signal is received after wave shaping and output waveform distortion will not guarantee a line;
- The built-in power on reset and reset circuit, the power does not work;
- gray level adjusting circuit (256 level gray scale adjustable);
- red drive special treatment, color balance;
- line data transmission;
- plastic forward strengthening technology, the transmission distance between two points over 10M;
- Using a typical data transmission frequency of 800 Kbps, when the refresh rate of 30 frames per sec

4. Mechanical Dimensions:

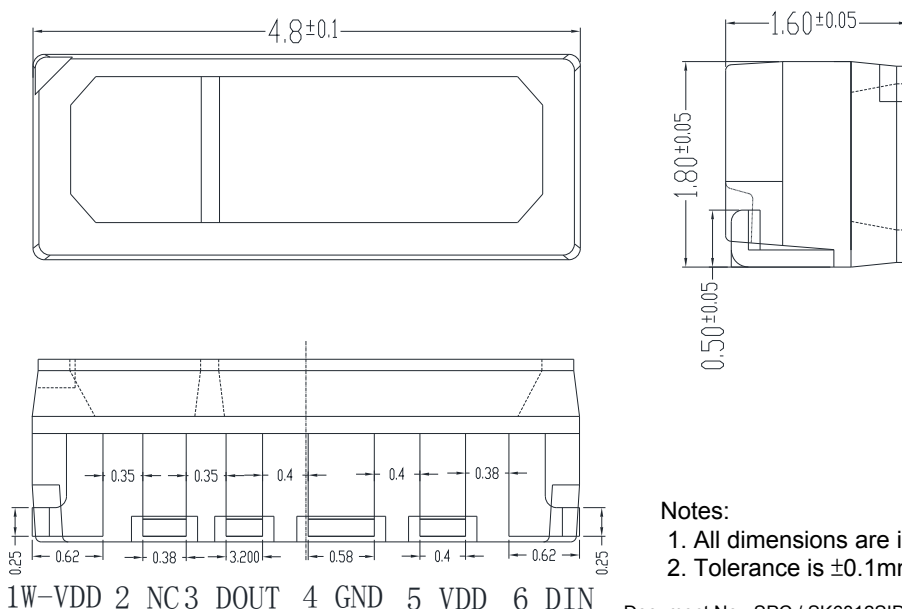

Notes:

1. All dimensions are in millimeters.
2. Tolerance is ± 0.1 mm unless otherwise noted

5. PIN configuration

NO.	Symbol	Function description
1	W-VDD	Power supply LED
2	NC	NC (This pin does not do circuit design)
3	DOUT	Control data signal output
4	GND	Ground
5	VDD	Power supply LED
6	DIN	Control data signal input

6. Recommended dimensions for PCB products

TOP VIEW

Temporarily omitted

7. General description of product naming.

SK 6812 SIDE-F RGBW-BW-P6

① ② ③ ④ ⑤

①	②	③	④	⑤
Series	IC series and current code	Boundary dimension	Light color type	Number of pins
The default is to integrate the RGB and X chip with the IC	Refers to the 68 series IC R/G/B 9MA current W:18MA current version	Side-f: refers to 4.8x1.8x1.6mm F-shaped outline package	R:RED G:GREEN B:BLUE W-BW: Blue White 5700-7500K	P6: 6 pins

Shenzhen Normand Electronic Co.,LTD

8. Electrical Parameters (Ta=25°C, VSS=0V) :

Parameter	Symbol	Range	Unit
Power supply voltage	VDD	+3.7~+5.5	V
Logic input voltage	V _{IN}	-0.5~VDD+0.5	V
Working temperature	T _{opt}	-40~+85	°C
Storage temperature	T _{stg}	-40~+85	°C
ESD pressure(HBM)	V _{ESD}	2K	V
ESD pressure(DM)	V _{ESD}	200	V

9. Electrical/Optical Characteristics:

Color	SK6812SIDEFRGBW-BW-P6		
	Dominate avelength(nm)	Luminance(mcd)	luminous flux(lm)
Red	620-630	240-450	/
Green	515-530	580-1050	/
Blue	460-475	160-320	/
WHITE	5500-7500K	2000-3800	6-11

10. The IC electrical parameters (unless otherwise specified, TA=-20 ~ +70 °C, VDD=4.5 ~ 5.5V, VSS=0V):

Parmeter	Symbol	Min	Typical	Max	Unit	Test conditions
The chip supply voltage	VDD	---	5.2	---	V	---
The signal input flip threshold	V _{IH}	0.7*VDD	---	---	V	VDD=5.0V
	V _{IL}	---	---	0.3*VDD	V	
The frequency of PWM	FPWM	---	1.2	---	KHZ	---
Static power consumption	IDD	---	1	---	mA	---

Shenzhen Normand Electronic Co.,LTD

11. Switching characteristics(Ta=25 °C):

Parameter	Symbol	Min	Typical	Max	Unit	Test conditions
The speed of data transmission	fDIN	---	800	---	KHZ	The duty ratio of 67% (data 1)
DOOUT transmission delay	TPLH	---	---	500	ns	DIN→DOOUT
	TPHL	---	---	500	ns	
IOOUT Rise/Drop Time	Tr	---	100	---	ns	VDS=1.5 IOOUT=9~18mA
	Tf	---	100	---	ns	

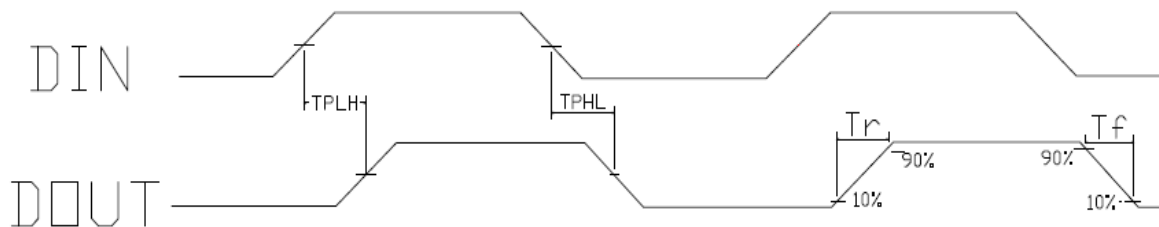

12. The data transmission time :

Name		Min.	Standard value	Max.	Unit
T	Code period	1.20	--	--	μs
T0H	0 code, high level time	0.2	0.35	0.4	μs
T0L	0 code, low level time	0.8	--	--	μs
T1H	1 code, high level time	0.58	0.64	1.0	μs
T1L	1 code, low level time	0.2	--	--	μs
Trst	Reset code, low level time	>80	--	--	μs

1. The protocol uses a unipolar zeroing code. Each symbol must have a low level. Each symbol in this protocol starts with a high level. The high time width determines the "0" or "1" code. .
2. When writing programs, the minimum symbol period is 1.2 μs.
3. The high time of "0" code and "1" code should be in accordance with the stipulated range in the above table. The low time requirement of "0" code and "1" code is less than 20 μs.

13. Timing waveform:

Input code:

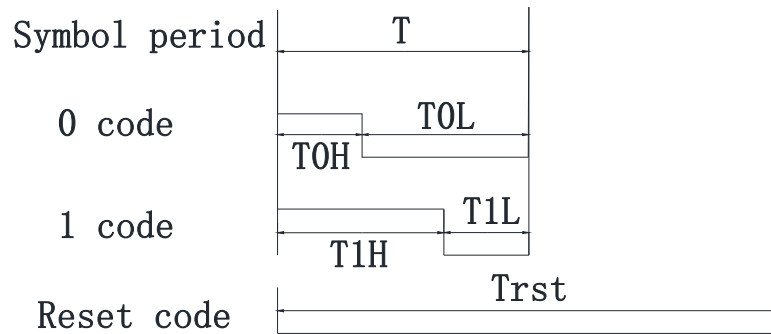

Connection mode:

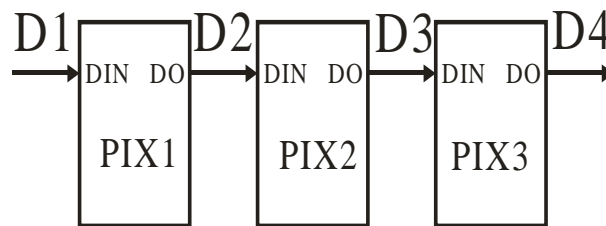

14. The method of data transmission:

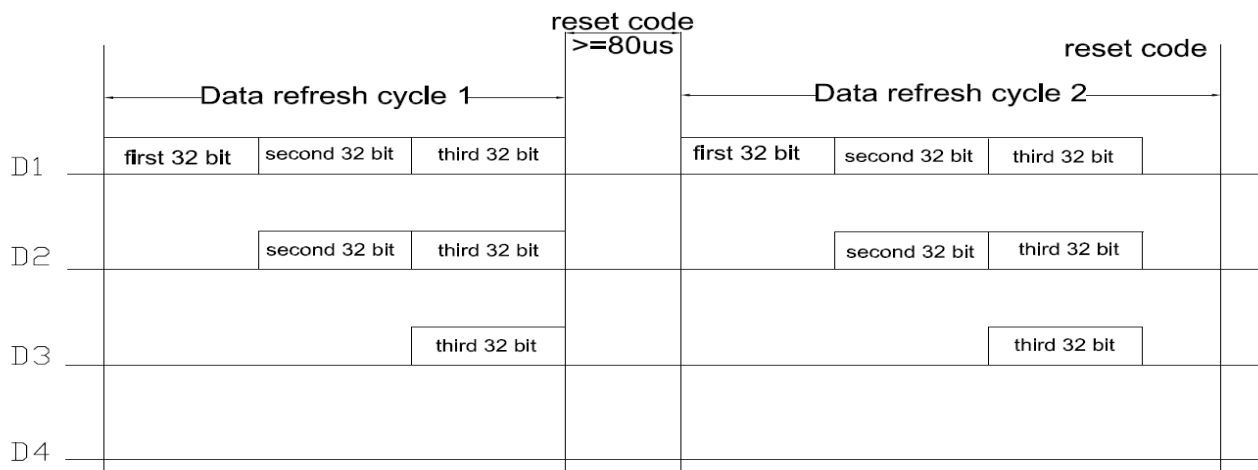

Note: the $D1$ sends data for MCU, $D2$, $D3$, $D4$ for data forwarding automatic shaping cascade circuit.

15. The data structure of 32bit:

G7	G6	G5	G4	G3	G2	G1	G0	R7	R6	R5	R4
R3	R2	R1	R0	B7	B6	B5	B4	B3	B2	B1	B0
W7	W6	W5	W4	W3	W2	W1	W0				

Note: high starting, in order to send data (G7 - G6 -W0)

16. The typical application circuit:

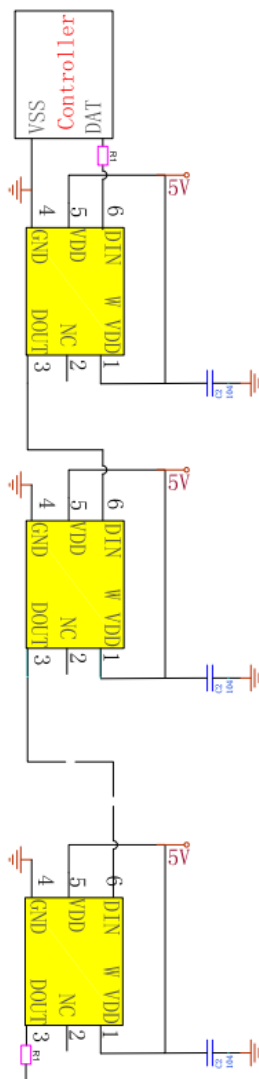

In the practical application circuit, the signal input and output pins of the IC signal input and output pins should be connected to the signal input and output terminals. In addition, in order to make the IC chip is more stable, even the capacitance between beads is essential back;

Application: used for soft lamp strip or hard light, lamp beads transmission distance is short, suggested in signal in time the clock line input and output end of each connected in series protection resistors, R1 of about 500 ohms.

Application: for module or general special-shaped products, lamp beads transmission distance is long, because of different wire and transmission distance, in the signal in time clock at both ends of the line on grounding protection resistance will be slightly different; to the actual use of fixed;

Shenzhen Normand Electronic Co.,LTD

17. Wavelength classification specification of red, green and blue

Name	Code	λ d MIN (nm)	λ d MAX (nm)
RED	HR1	620	625
	HR2	625	630
BLUE	BL5	460	465
	BL6	465	470
GREEN	PG2	515	520
	PG3	520	525
	PG4	525	530

Shenzhen Normand Electronic Co.,LTD

18. White Color Temperature Ranks & CIE Color Rank (Refer to CIE 1931 chromaticity diagram)

CIE chromaticity coordinates (ANSI Cool White)

名称	X1	Y1	X2	Y2	X3	Y3	X4	Y4
CA	0.305649	0.30617	0.29869	0.31022	0.30422	0.31765	0.31118	0.3136
CB	0.311181	0.3136	0.30422	0.31765	0.30975	0.32508	0.31671	0.32103
CC	0.316713	0.32103	0.30975	0.32508	0.31529	0.33252	0.32225	0.32847
CD	0.322245	0.32847	0.31529	0.33252	0.32082	0.33995	0.32778	0.3359
CE	0.327777	0.3359	0.32082	0.33995	0.32635	0.34738	0.33331	0.34333

ANSI Blue White Color bin structures

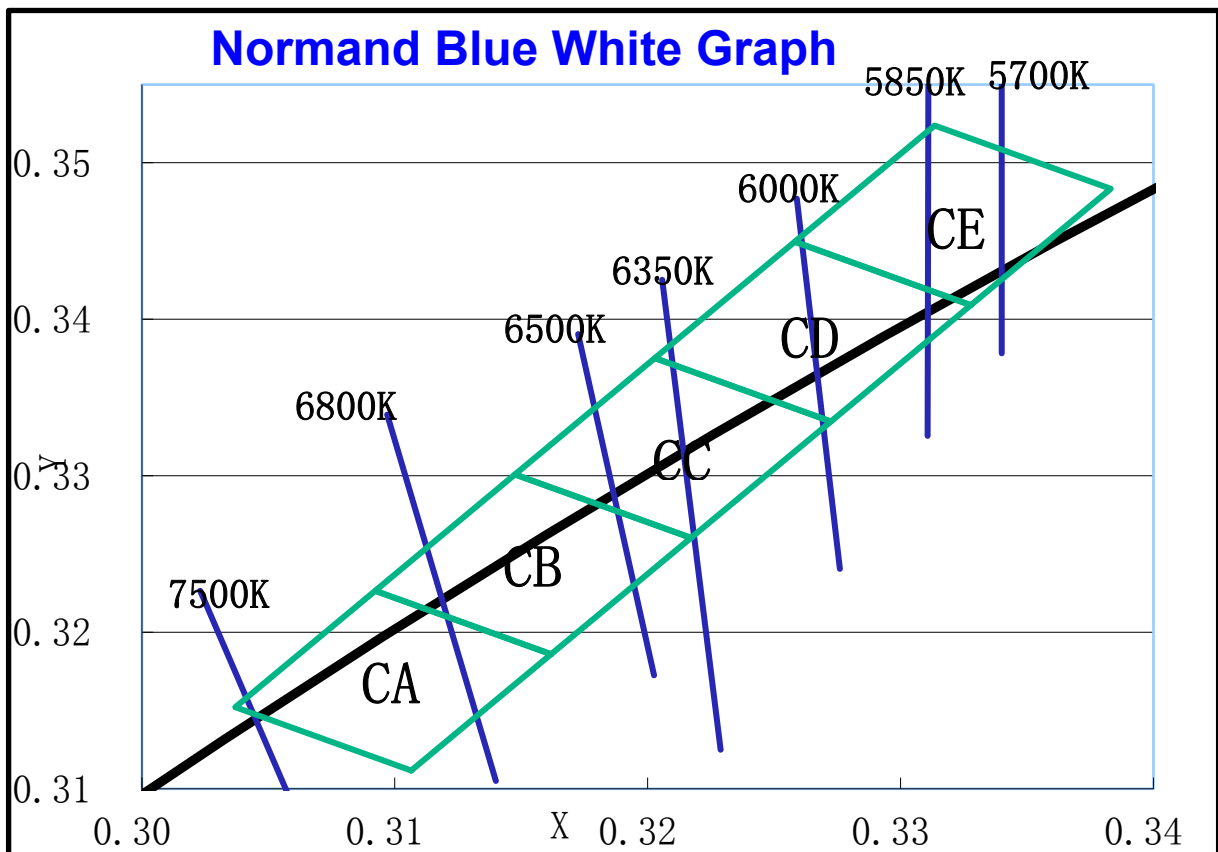

19. Standard LED Performance Graph:

Thermal Pad Temperature vs. Relative Light Output

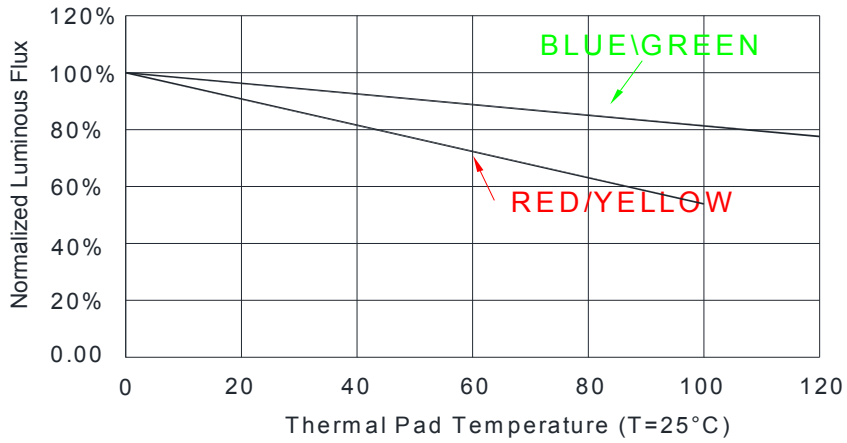

Wavelength Characteristics

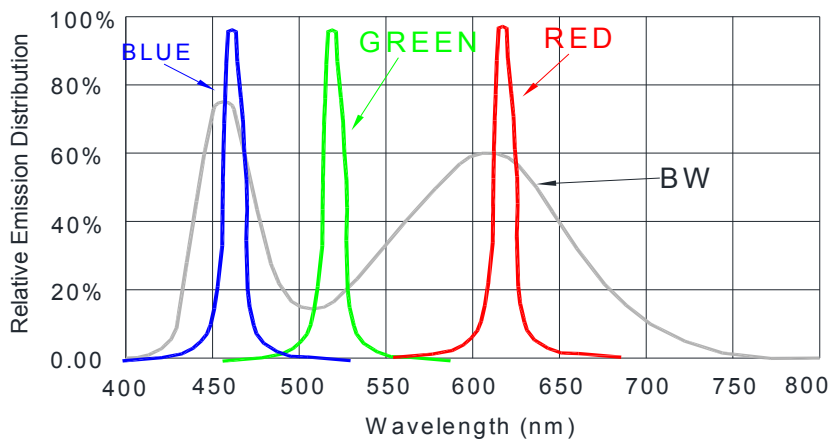

Typical Radiation Pattern 120°

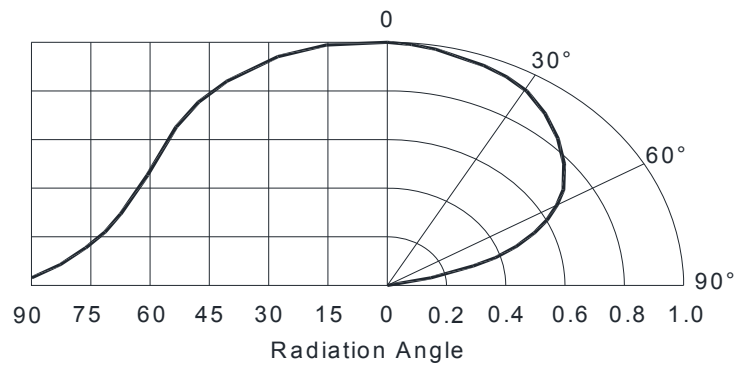

20. Packaging Standard:

Temporarily omitted

The reel pack is applied in SMD LED. The LEDs are packed in cardboard boxes after packaging in normal or anti-electrostatic bags. cardboard boxes will be used to protect the LEDs from mechanical shocks during transportation. The boxes are not water resistant and therefore must be kept away from water and moisture.

Shenzhen Normand Electronic Co.,LTD

21. Reliability Test :

NO.	Test item	Test Conditions	Reference	Criterion
1	Thermal Shock	100 ± 5° C ~ -40° C ± 5° C 30min~30min 300 cycles	MIL-STD-202G	0/22
2	High Temperature Storage	Ta= +100° C 1000hrs	JEITA ED-4701 200 201	0/22
3	Low Temperature Storage	Ta= -40° C 1000hrs	JEITA ED-4701 200 202	0/22
4	High Temperature High Humidity Storage	Ta=60° C RH=90% 1000hrs	JEITA ED-4701 100 103	0/22
5	Temperature Cycle	-55° C~25° C~100° C~25° C 30min~5min~30min~5min 100 cycles	JEITA ED-4701 100 105	0/22
6	Resistance to Soldering Heat	Tsld = 260° C, 10sec. 3 times	JEITA ED-4701 300 301	0/22
7	Room temp Life Test	25° C, IF: Typical current , 1000hrs	JESD22-A 108D	0/22

Criteria for Judging the Damage:

Item	Symbol	Test Condition	Limit	
			Min	Max
Luminous Intensity	IV	DC=5V, Typical current	Init. Value*0.7	---
Resistance to Soldering Heat	---	DC=5V, Typical current	No dead lights or obvious damage	

Appendix 1.TOP SMD LED Application Notes

1. Features

The Purposes of making Normand's customers and users to have a clear understanding on the ways how to use the LED.

2. Description

Generally. The LED can be used the same way as other general purposed semiconductors. When using Normand's TOP SMD LED, the following precautions must be taken to protect the LED.

3. Cautions

3.1. Dust & Cleaning

This emitter has a silicone surface, There are many benefits to the silicone surface in terms of optical properties and improved reliability. However, silicone is a softer material and prone to attract dust. While a minimal amount of dust and debris on the LED will not cause significant reduction in illumination, steps should be taken to keep the emitter free of dust.

These include keeping the LEDs in the manufacturer's package prior to assembly and storing assemblies in an enclosed area after installing the emitters.

Surface condition of this device may change when organic solvents such as trichloroethylene or acetone were applied.

Avoid using organic solvent, it is recommended that isopropyl be used as a solvent for cleaning the LEDs. When using other solvents, it should be confirmed beforehand whether the solvents will dissolve the package and the resin or not.

Do not clean the LEDs by the ultrasonic. When it is absolutely necessary, the influence as ultrasonic cleaning on the LEDs depends on factors such as ultrasonic power. Baking time and assembled condition. Before cleaning, a pre-test should be done to confirm whether any damage to the LEDs will occur.

3.2. Shipment and storage

TOP SMD LED is a humidity sensor, the LED packaging in the aluminum bag is to avoid the LED in the transport and storage of moisture absorption, in the bag with a desiccant to absorb the moisture inside the bag. If the LED absorbs water vapor, then in the LED over reflow, in the high temperature state, into which the rapid expansion of gas vaporization and produce a greater internal stress, so that the material crack, layered or damaged bonding wire , Resulting in product failure.

TOP SMD LED with a moisture-proof anti-static aluminum foil bag packaging, handling should avoid the process of squeezing, piercing the case of bags, and do the necessary anti-static protective measures; promise products on the line before the leak or broken, Please stop the use of direct use of the product; , Resulting in product failure;

Such as before the material has been found to prevent moisture-proof aluminum foil bags have been opened, damaged, perforated can be returned to the original re-dehumidification, must not be on-line use;

The humidity level of this product is LEVEL5a.

Shenzhen Normand Electronic Co.,LTD

Chart 1:Definition of material' s MSL prescribed by IPC/JEDECJ-STD-020E

Moisture proof	Workshop lifespan after open the packaging	
	Time	condition
LEVEL1	unlimited	$\leq 30^{\circ}\text{C}/85\% \text{ RH}$
LEVEL2	1 year	$\leq 30^{\circ}\text{C}/60\% \text{ RH}$
LEVEL2a	4 Weeks	$\leq 30^{\circ}\text{C}/60\% \text{ RH}$
LEVEL3	168 Hours	$\leq 30^{\circ}\text{C}/60\% \text{ RH}$
LEVEL4	72 Hours	$\leq 30^{\circ}\text{C}/60\% \text{ RH}$
LEVEL5	48 Hours	$\leq 30^{\circ}\text{C}/60\% \text{ RH}$
LEVEL5a	24 Hours	$\leq 30^{\circ}\text{C}/60\% \text{ RH}$
LEVEL6	Take off and use immediately	$\leq 30^{\circ}\text{C}/60\% \text{ RH}$

3.3. Storage before unsealing

In order to avoid the moisture barrier caused by the reliability of the failure problem, need to do LED products SMT pre-storage and moisture-proof measures;

If the moisture-proof bag is not open, the TOP SMD element will be stored for less than 2 months at $<30^{\circ}\text{C} / 60\% \text{ RH}$; (Note: The label date is the same and the packing is not leaked. Discoloration under the premise of use; for different moisture-proof grade materials or packaging to save the time there is a certain difference, the specific preservation time to the specification book or packaging tips prevail); recommended in the unassembled do not open the moisture before the bag;

3.4. Control after the packing bag is opened

After opening the moisture-proof bag, please read the moisture-proof bag inside the humidity indicator card in the moisture-proof beads into pink to confirm moisture in the moisture bag is too much, according to the color of the ball to determine whether the bag material on-line operation; And the material after opening the package should be strictly controlled in the table 1 as specified by the maximum temperature and humidity and operating time allowed, as long as the material exposed in the environment described in Table 1, the need to accumulate its use in the workshop time.

Open the bag and paste the material on the PCB board, should be completed within 0.5H welding work, do not recommend the material attached to the PCB, a long time stay in the workshop does not carry out SMT work; Caused by adverse water within the lead;

3.5. Definition of humidity card

Open the package after the TOP SMD LED bag inside the humidity card color instructions are as follows:

- If the moisture card 10% of the moisture-proof beads into pink, other files for the blue, this situation, LED can be used directly;
- If the humidity card moisture-proof beads 10%, 20% at all become pink, in fact, the file is blue, this situation, the need for low-temperature components dehumidification;
- If the humidity card moisture-proof beads 10%, 20%, 30% more than three are turned pink, in this case, the customer needs to return the material to our company for high humidity dehumidification, re-packaging before use;

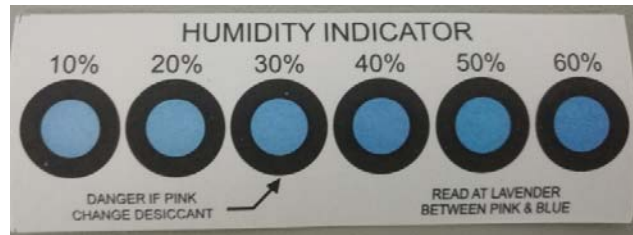

Humidity indicator D0 not change color

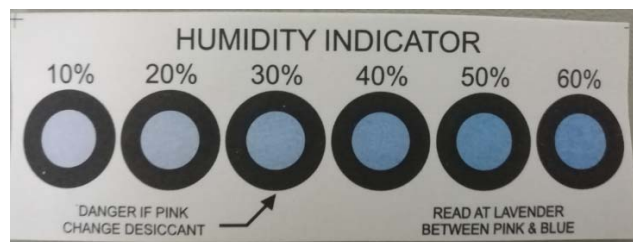

Humidity indicator turns pink in 10% 20%

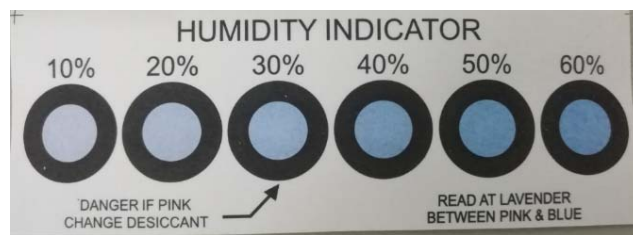

Humidity indicator turns pink in 10% 20% 30%

3.6. Unwanted material moisture-proof storage and moisture-proof control of finished material

If a roll of SMDs is not used at once and the plant temperature and humidity are within the defined conditions ($<30^{\circ}\text{C}$ / $60\% \text{RH}$), the exposure time of the element in the air does not exceed 2H, the remaining material should be carried out together with the desiccant Vacuum sealed, otherwise, the material must be low-wet baking dehumidification; dehumidified material can be re-packaged to re-start the calculation time;

Perform moisture control on SMDs components that have been assembled

- After the components have been assembled to the PCB board no longer need to go through the high temperature process or reflow process, it will not be special treatment;
- Do not need to do the necessary dehumidification work before making the appropriate protection process, bake in $70^{\circ}\text{C} \pm 5^{\circ}\text{C}$ oven baking for less than 48 hours, To remove the product in the detection and aging process exposed to moisture in the air to avoid the product in the protective treatment, the package in the material surface of the moisture will slowly invade the product, will cause product failure (Specific desiccant baking parameters refer to 3.6.2 items);
- For products that require secondary SMT process or high temperature, they should be subjected to the necessary moisture treatment before secondary welding, after exposure to ($<30^{\circ}\text{C}$ / $60\% \text{RH}$), The maximum length of not more than 4H, Connaught second high temperature process separated by a long time, then a welding material must be necessary dehumidification work ($70^{\circ}\text{C} \pm 5^{\circ}\text{C}$ oven baking no less than 48 hours), and then pumping Vacuum storage; or the first product stored in the oven or with a desiccant container, the second high-temperature process before doing dehumidification work ($70^{\circ}\text{C} \pm 5^{\circ}\text{C}$ in the oven baking no less than 48 hours), To ensure that products in the high temperature before the process is not damp (Specific desiccant baking parameters refer to 3.6.2 items);

Low-temperature baking conditions: $70^{\circ}\text{C} \pm 5^{\circ}\text{C}$ baking not less than 48 hours high temperature baking conditions: $130^{\circ}\text{C} \pm 5^{\circ}\text{C}$ baking not less than 6 hours (lamp beads must be split into particles)

Shenzhen Normand Electronic Co.,LTD

3.6.2 The relationship between ambient humidity and dehumidification time for low temperature/high temperature dehumidification:

Ambient humidity	Oven temperature	baking time	Baking method
40%	70C°	24H	Remove from the static bag and bake with the reel to dehumidify.
50%	70C°	48H	
>60%	70C°	Ineffective dehumidification baking	
40%	130C°	6H	Lamp beads must be dismantled into granules to bake and dehumidify
50%	130C°	12H	

3.7. Reflow Soldering Characteristics

In testing, Normand has found S50 LEDs to be compatible with JEDEC J-STD-020E, using the parameters listed below. As a general guideline Normand recommends that users follow the recommended soldering profile provided by the manufacturer of solder paste used.

Note that this general guideline is offered as a starting point and may require adjustment for certain PCB designs and Configurations of reflow soldering equipment.

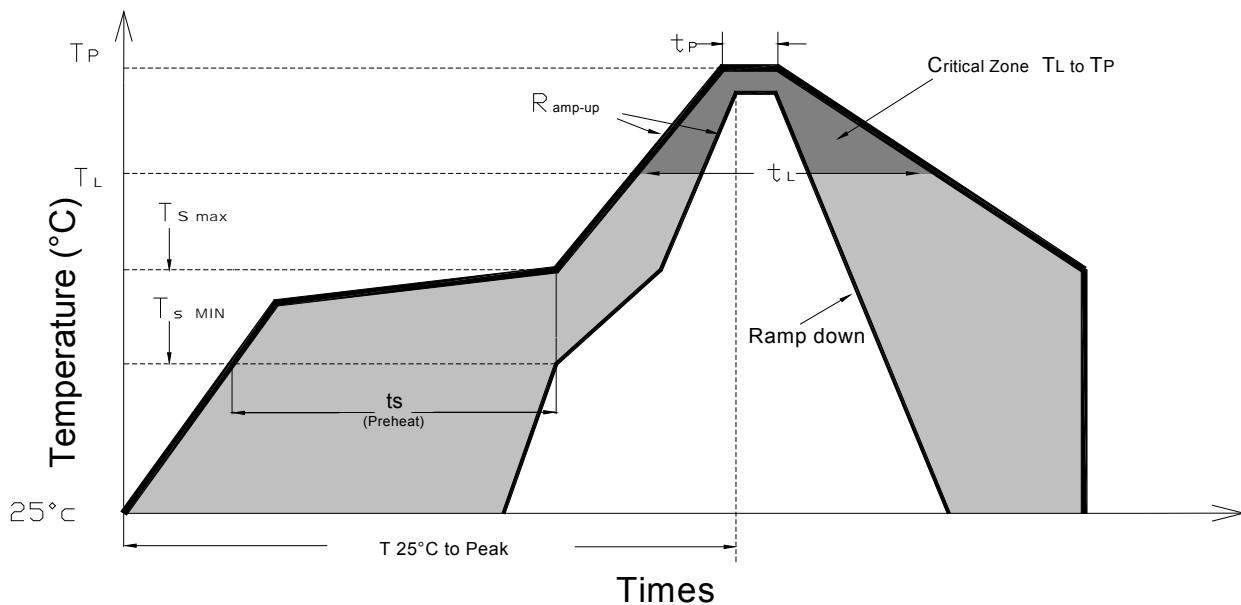

Shenzhen Normand Electronic Co.,LTD

Profile Feature	Lead-Based Solder	Lead-Free Solder
Average Ramp-Up Rate ($T_{s_{max}}$ to T_p)	3°C/second max.	3°C/second max.
Preheat: Temperature Min ($T_{s_{min}}$)	100°C	150°C
Preheat: Temperature Min ($T_{s_{max}}$)	150°C	200°C
Preheat: Time ($t_{s_{min}}$ to $t_{s_{max}}$)	60-120 seconds	60-180 seconds
Time Maintained Above: Temperature (T_L)	183 °C	217 °C
Time Maintained Above: Time (t_L)	60-150 seconds	60-150 seconds
Peak/Classification Temperature (T_p)	215 °C	240 °C
Time Within 5°C of Actual Peak Temperature (t_p)	<10 seconds	<10 seconds
Ramp-Down Rate	6°C/second max.	6°C/second max.
Time 25 °C to Peak Temperature	<6 minutes max.	<6 minutes max.

Note: All temperatures refer to topside of the package, measured on the package body surface.

3.8 Heat Generation:

Thermal design of the end product is of paramount importance. Please consider the heat generation of the LED when making the system design. The coefficient of temperature increase per input electric power is affected by the thermal resistance of the circuit board and density of LED placement on the board, as well as components. It is necessary to avoid in tense heat generation and operate within the maximum rating given in this specification. The operating current should be decided after considering the ambient maximum temperature of LEDs

The maximum working temperature of the product is not easy to exceed 60 ° C (≤ 60 ° C, refers to the product pin at the operating temperature)

3.9 Electrostatic Discharge & Surge Current :

Electrostatic discharge (ESD) or surge current (EOS) may damage LED.

Precautions such as ESD wrist strap, ESD shoe strap or antistatic gloves must be worn whenever handling of LED.

IC device signal input and output ports must be connected in series protection resistor to prevent surge or static shock port caused by product failure;

All devices, equipment and machinery must be properly grounded.

It is recommended to perform electrical test to screen out ESD failures at final inspection.

It is important to eliminate the possibility of surge current during circuitry design.

4.0 Moisture Proof Package

Cannot take any responsibility for any trouble that are caused by using the LEDs at conditions exceeding our specifications.

The LED light output is strong enough to injure human eyes. Precautions must be taken to prevent looking directly at the LEDs with unaided eyes for more than a few seconds.

The formal specification must be exchanged and signed by both parties before large volume purchase begins.

The appearance and specifications of the product may be modified for improvement without notice.